

Škoda Octavia 5e

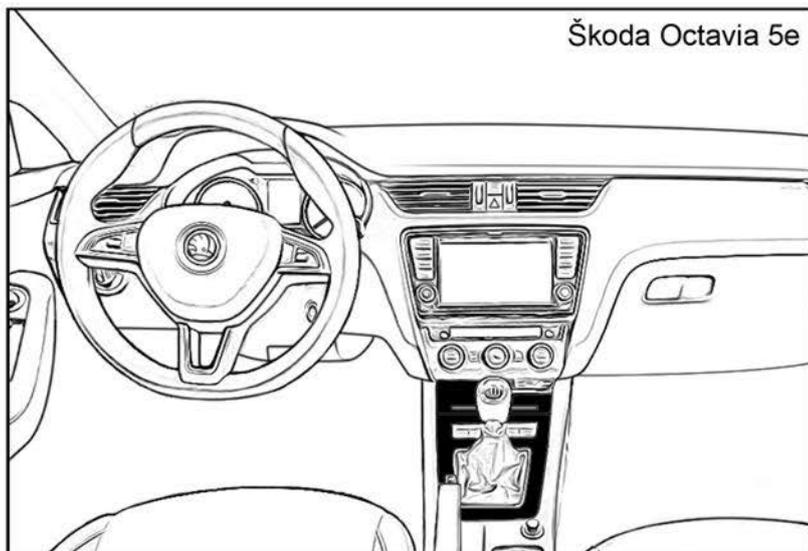

HS-CNC⁶

Carbon Blenden
Montageanleitung
Montage restliches Sortiment analog

Carbon Covers
mounting instructions
same steps apply to all covers

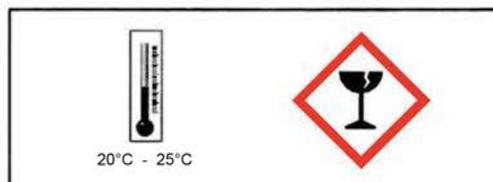

Lieferumfang | scope of supply

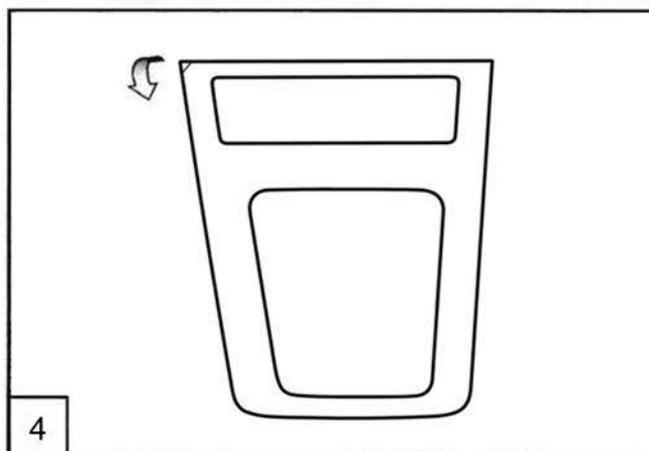
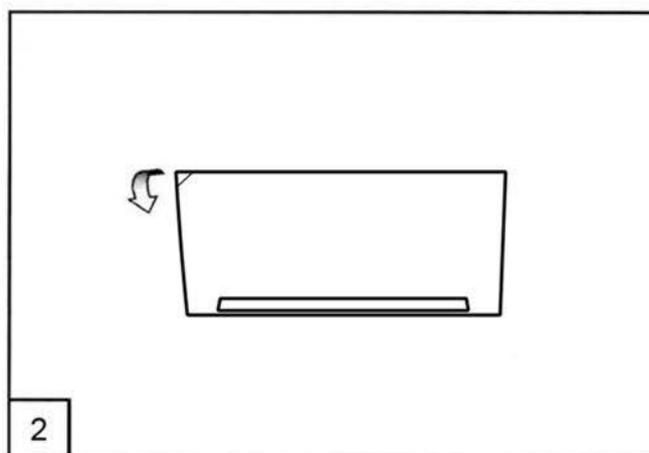
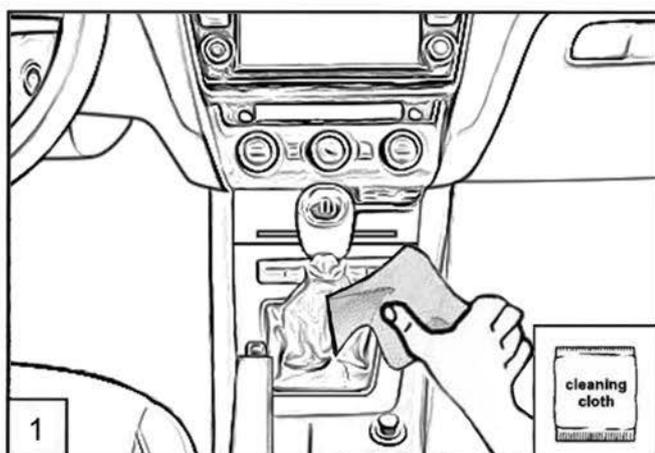
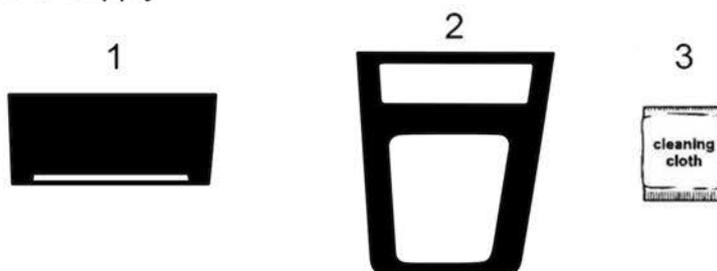

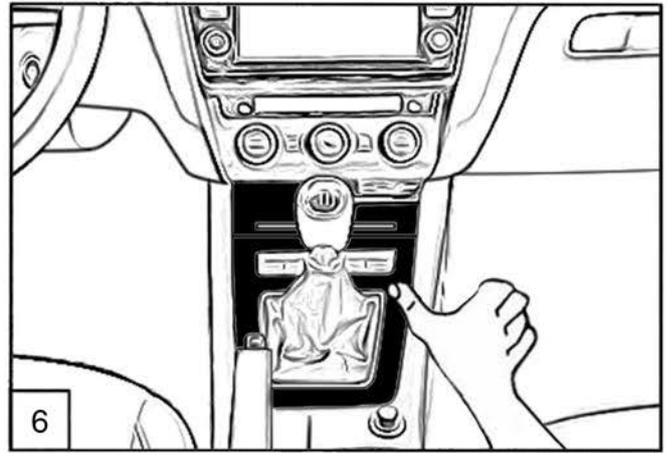

Verwendungshinweis Primer

Der Primer erhöht die Haftkraft des Klebers an stark beanspruchten Abschnitten der Blende, tragen Sie ihn dünn an den gezeigten Flächen im Fahrzeuginnern auf und lassen Sie ihn kurz trocknen.

Im Fall des Rückbaus lässt sich der Primer mit Isopropylalkohol rückstandslos entfernen.

3M Primer 94





Hinweise beachten!
Sicherheitsdatenblatt unter:
www.hs-cnc.de/datasheet

Instructions for Use

The Primer promotes the adhesion of the mounting tape. The carbon fiber covers are under slight tension when mounted on curved surfaces, therefore the primer is used in these areas to ensure an lasting bond.

If you want to remove the covers at a later time the primer can be removed with isopropyl alcohol.

3M Primer 94





Heed Warnings!
Safety Data Sheet:
www.hs-cnc.de/datasheet

